

Juscar DASH CAM OPERATING INSTRUCTIONS

(For information only)



CONTENTS

1. English.....	3~27
2. Caution.....	3
3. Video damage or loss can occur in the following situations.....	3
4. FCC ID: 2BH7S-KL.....	3
5. Preface.....	4
6. Product Accessories Listing.....	5
7. Product construction description.....	6
8. Host button and interface description.....	7
9. Host installation method.....	8
10. Bracket installation.....	9
11. Connect power supply(Car Charge).....	10
12. Connect power supply(Hard wire Kit).....	11
13. Rear lens installation.....	12
14. Logger Initial Settings.....	13
15. Recorder function description.....	14~21
16. WIFI connection.....	22~23
17. Manual one-touch file lock function.....	24
18. Product specification sheet.....	25
19. Troubleshooting.....	26
20. Disclaimer.....	27
21. Español.....	28~30
22. Deutsch.....	31~33
23. Français.....	34~36
24. Italiano.....	37~39
25. 日本語.....	40~42

Caution

- ◆ Do not disassemble the machine yourself to avoid affecting the scope of the warranty.
- ◆ Please find a professional for the modification of the power line.
- ◆ Please do not operate this product while driving to avoid distraction and affect driving safety.
- ◆ Due to the development of technology, we may make some changes or upgrades to the software or hardware, resulting in inconsistencies with the manual, we will no longer issue a change notice.
- ◆ We ask the user to refer to the actual product, please forgive us!

Video damage or loss can occur in the following situations:

- ◆ During recording, removing the TF card can cause damage or loss to the last recorded file.
- ◆ During recording, Illegal power outage can cause damage or loss to the last recorded file.
- ◆ During recording, Machine suffers from Caused by destructive collisions , can cause damage or loss to video recorded file.
- ◆ During recording, due to excessive collision Causing the TF card to become loose can cause damage or loss to video recorded file.

FCC ID: 2BHTS-KL

- ◆ This device complies with part 15 of the FCC Rules. Operation is subject to the following two conditions:
- ◆ (1) This device may not cause harmful interference, and (2) this device must accept any interference received, including interference that may cause undesired operation.

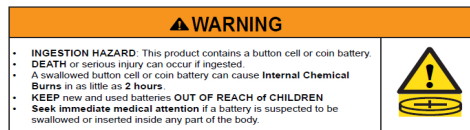

- Remove and immediately recycle or dispose of used batteries according to local regulations and keep away from children. Do NOT dispose of batteries in household trash or incinerate.
- Even used batteries may cause severe injury or death.
- Call a local poison control center for treatment information.
- The compatible battery type (Not compatible with other battery models).
- The nominal battery voltage
- Non-rechargeable batteries are not to be recharged.
- Do not force discharge, recharge, disassemble, heat above or incinerate. Doing so may result in injury due to venting, leakage or explosion resulting in chemical burns.

Preface

Thank you very much for purchasing 'JUSCAR' products, this product is a product developed specifically for today's traffic accident forensics difficulties; at the same time to meet the needs of other occasions, can be used for meeting records, surveillance forensics, location shooting, forensics camera, etc., can let you multi-purpose, let your life more colorful.

The product combines industry-leading technology such as **super night vision, seamless loop camera, super wide angle shooting and real time playback with its own display, etc.** The unique and stylish streamline design is favoured by the majority of consumers.

This manual will explain in detail how to install, operate, product parameters and precautions. Please read it carefully before use and keep it safe. We hope this product will meet your needs and serve you for a long time! However, as specifications are subject to change due to upgrades, updates etc., please refer to the actual product without prior notice. The manufacturer reserves the right to change the technology directly without prior notice.

Copyright infringement / privacy notice

Please note that this product is intended for personal use only and should not be used in such a way as to infringe national or international copyright/privacy laws. This means that the recorded images are for personal use only and are not to be distributed to the public; in addition, in some cases the use of this product to record images of performances, exhibitions or commercial events may infringe the copyright or legal rights of others.

Installation instructions

This product should be installed close to the rear view mirror for the best possible view.
Make sure that the lens is within the windscreen wiper range to ensure a good view, even in rainy conditions.
Do not touch the lens with your fingers, as grease from your fingers may remain on the lens and cause unclear video or photography, so please clean the lens regularly.

Product Accessories Listing (Image for reference only)

If there are any missing or damaged items, please contact **seller** immediately.

Standard/Optional



G90 4K Dash Cam



Fixed bracket



Suction cup bracket



Hard wire Kit (Be purchased separately)

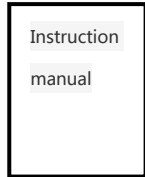

Instruction manual



Rear view lens (Optional)

3 Channels standard



Car Charge



GPS module

The above pictures are for reference only, if there is any inconsistency between the images and actual product you receive, the actual product will govern.

Product construction description (Image for reference only)

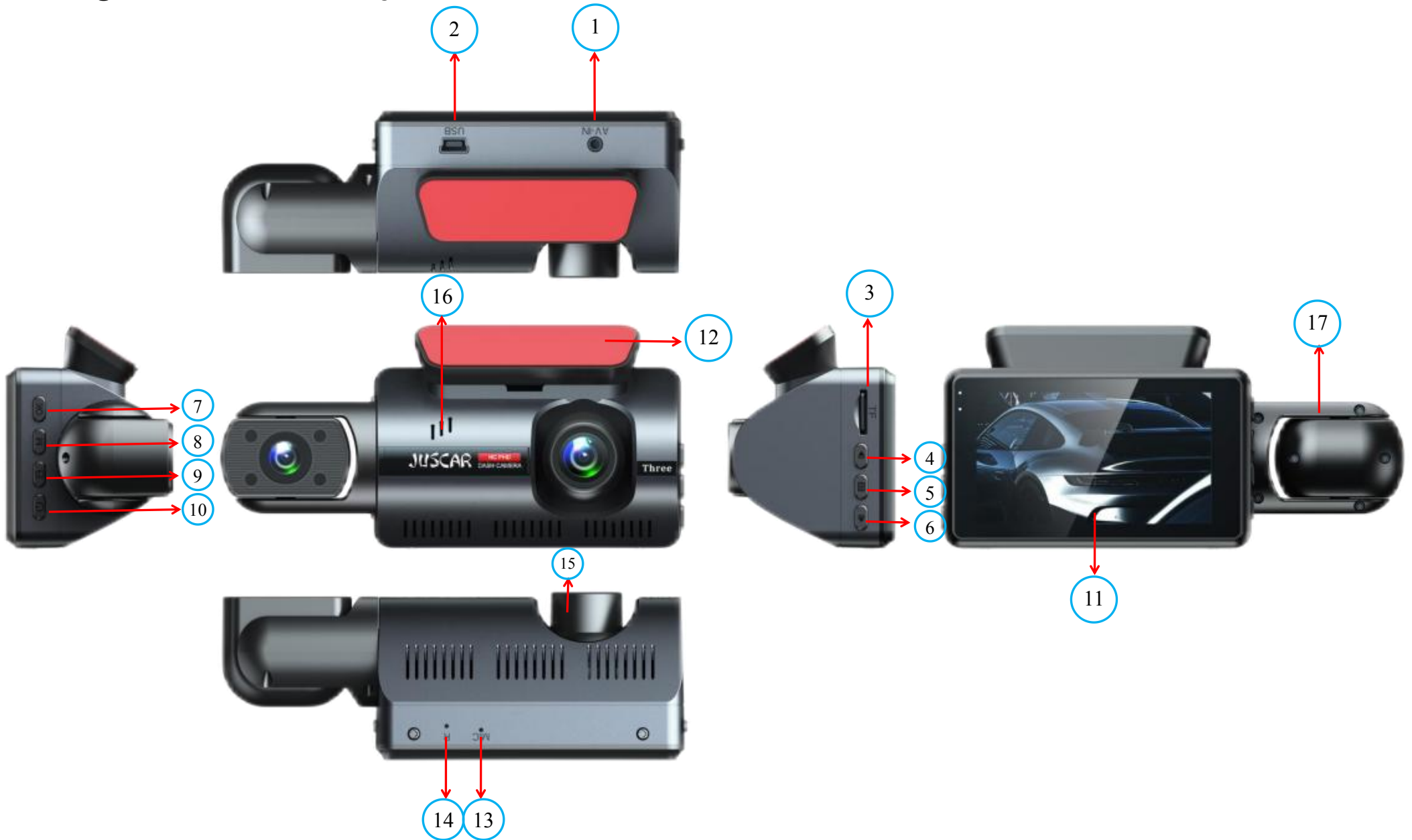

Host button and interface description

No.	Name	Operation Instructions
1	AV interface	rear recording lens interface
2	USB interface	5V DC power supply interface
3	TF card slot	TF memory card slot, please follow the correct direction to install
4	Up button	In the menu mode and file browsing mode, it is the page up function. In standby mode, video mode, short press the key to switch the front and back screen display
5	menu button	In standby, recording, and mode, short press to directly enter playback mode, and then press to switch video options; Long press for 3 seconds to return to the recorder page
6	Down button	In the menu mode and file browsing mode, it is the page down function. In standby mode, video mode, short press the button to take a snapshot
7	OK button	In the recorder interface, short press the OK button to start/stop the recording function. It is the confirmation key in the other function setting interface
8	M button	In standby mode, short press the M button to switch to the function selection interface, long press M button to turn on or turn off Wi-Fi.
9	One key lock button	In the video mode, short press a key to lock and protect the video. (Prevent video auto loop coverage)
10	Power button	Long press to turn on/off ; short press to turn on/off the screen backlight in standby or video mode
11	Display screen	3.0-inch HD display.
12	Bracket	mounting bracket
13	MIC	sound recording
14	Reset button	System restart reset button
15	Camera	Front cam wide-angle lens
16	Horn hole	Speaker installation position
17	Incar camera	Record car interior video

Host installation method:

◆ TF card installation

1. Insert the memory card: Please insert the memory card in the correct direction as prompted by the memory card notch on the device, press the memory card until it clicks and insert it in place.

Since the video storage of the recorder has a high operating speed to the card, note that the memory card must be a high-speed card (above CLASS10 , support min 8GB, max512GB).

Note: For the first use of a new card, it must be formatted and matched in this machine.

2. Take out the memory card: Press the memory card to eject the slot.

Note: When the device is turned on, do not remove or insert the memory card to avoid damage to the memory card or loss of files.



◆ **Installation method for 3M bracket:**

Push the 3M adhesive into the host card slot in the direction shown in the diagram, After removing the red adhesive paper, fix it onto the front windshield as shown in the diagram.

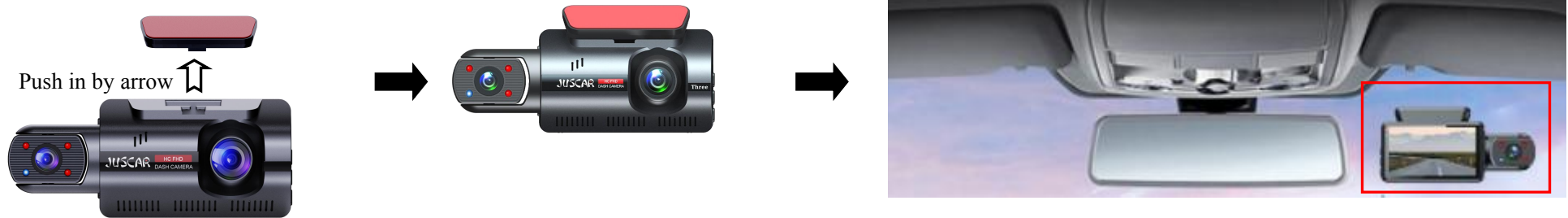

◆ **Installation method of suction cup bracket:**

Insert the suction cup bracket into the host card slot in the direction shown in the diagram, remove the protective film from the bracket, press the movable bracket of the bracket, and attach it to the front windshield as shown in the diagram.



◆ Connect power supply(Car Charge)

- (1) connect the in-car power cord to the event data recorder's Type-c interface using the factory standard charger.
- (2) the event data recorder is affixed to the front windshield of the car with a fixed bracket.
- (3) install it near the rearview mirror as far as possible.
- (4) Lay the car power cord along the edge of the car windshield. Plug the cigarette end into the car lighter.
- (5) the GPS module is connected in series to the power cord, the module plug is connected to the Type-c interface of the event data recorder, and the car charging Type-c interface is inserted into the GPS module.

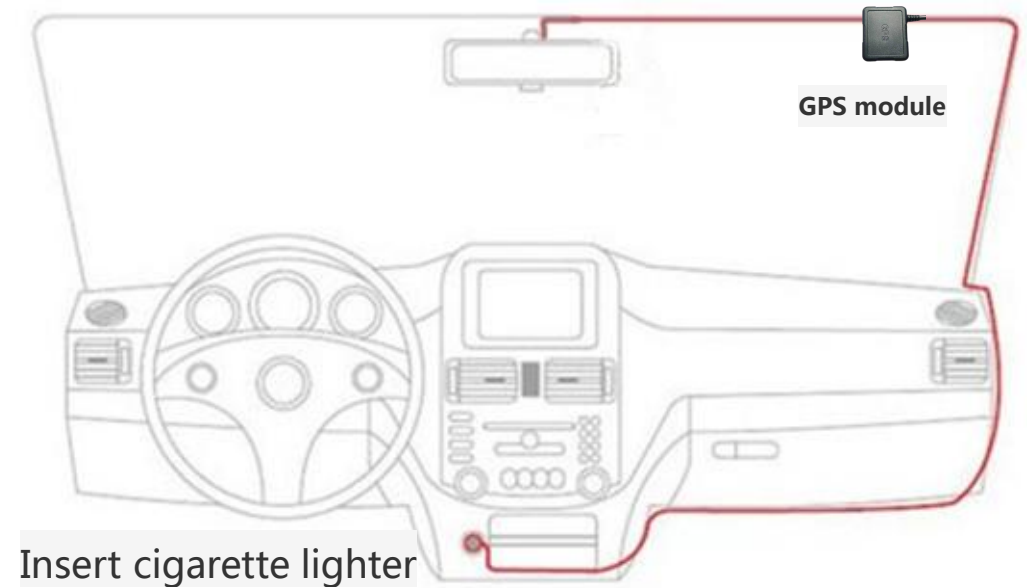
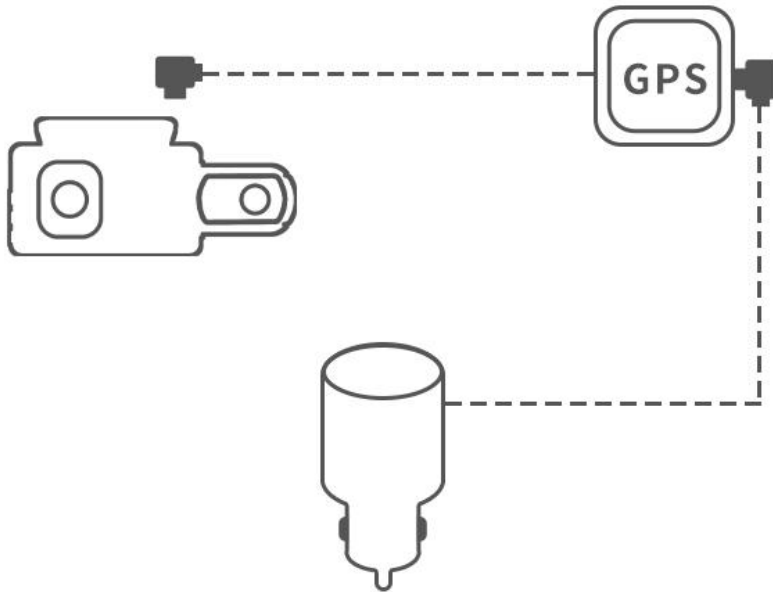

◆ **Connect power supply(Hard wire Kit) (Be purchased separately)**

- (1) Please use the factory standard original Hard wire Kit to connect the car power cord to the Type-c interface of the dash cam.
- (2) The dash cam is attached to the front windshield of the car with a fixed bracket.
- (3) Install as close to the interior rear view mirror as possible, with a better visual field.
- (4) Lay the onboard power cord along the edge of the car windshield. Connect the car power supply to the car fuse box. Connect the black wire to ground and the red wire to ACC; Connect the yellow wire to B+long current.

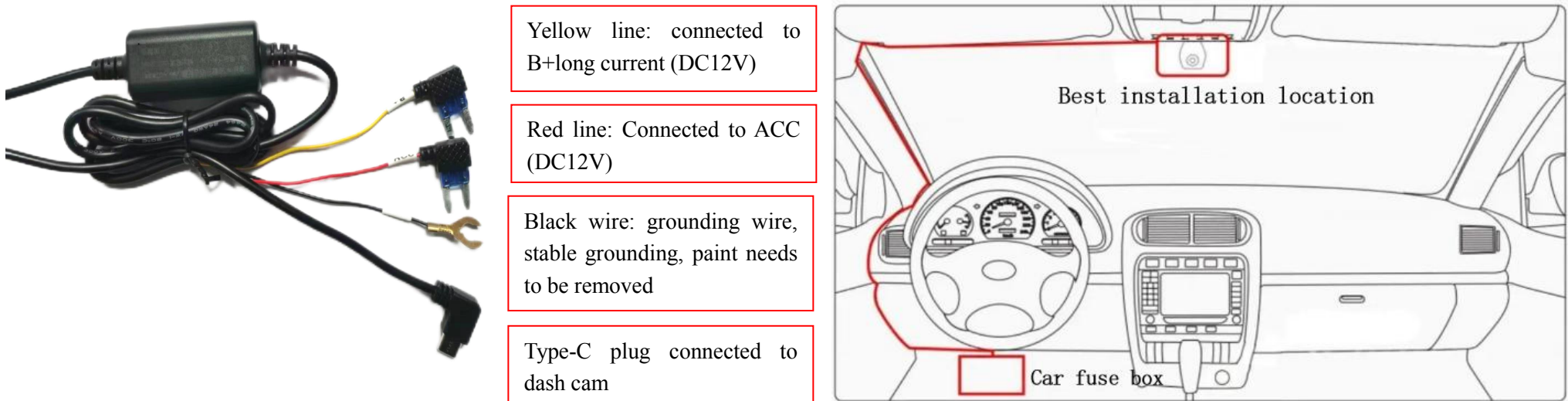

Note: When installing the Hard wire Kit,It is necessary to use an electric pen to measure whether the voltage is 12V and whether the key is powered to determine which line is a long charge and which line is ACC, in order to correctly connect the wires., as shown in the above figure.

Rear lens installation (3 Channels recording Optional)

◆ The rear lens is installed on the car's rear windshield:

After tearing off the 3M red adhesive paper, fix it onto the rear windshield.

◆ The rear lens is installed above the license plate :

Fix the rear lens onto the license plate with small screws, adjust the angle to achieve the best reverse angle for the rear lens. the wiring of the rear lens can enter the car through the gap of the license plate light, to achieve concealed installation

◆ The rear lens connect power supply

The red wire on the extension line of the rear camera (optional) is connected to the positive pole of the reversing light. This red line is used for the screen to automatically switch the reversing image when the car is in reverse gear. If the red line is not connected, it will not affect the normal video recording. You can choose whether to connect or not connect the red line according to the actual situation.

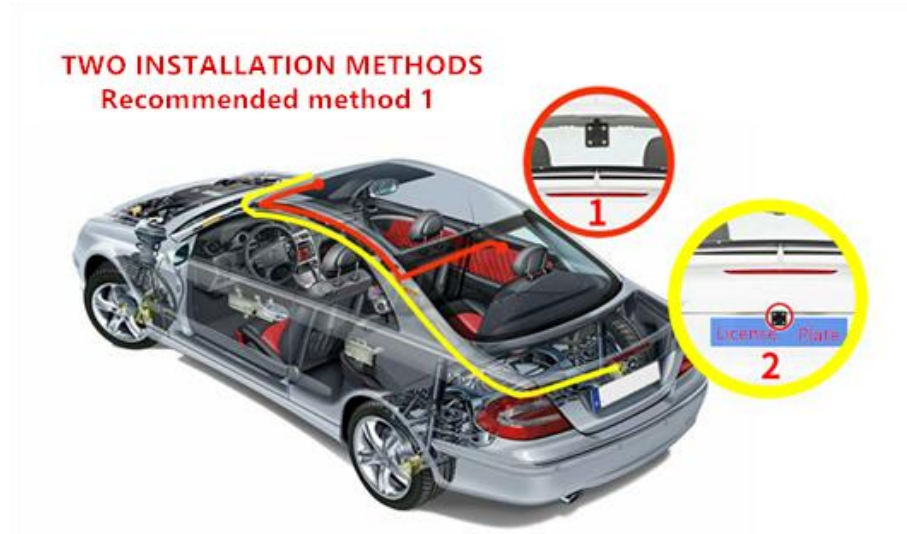

Distribution diagram of rear camera (optional) extension cable





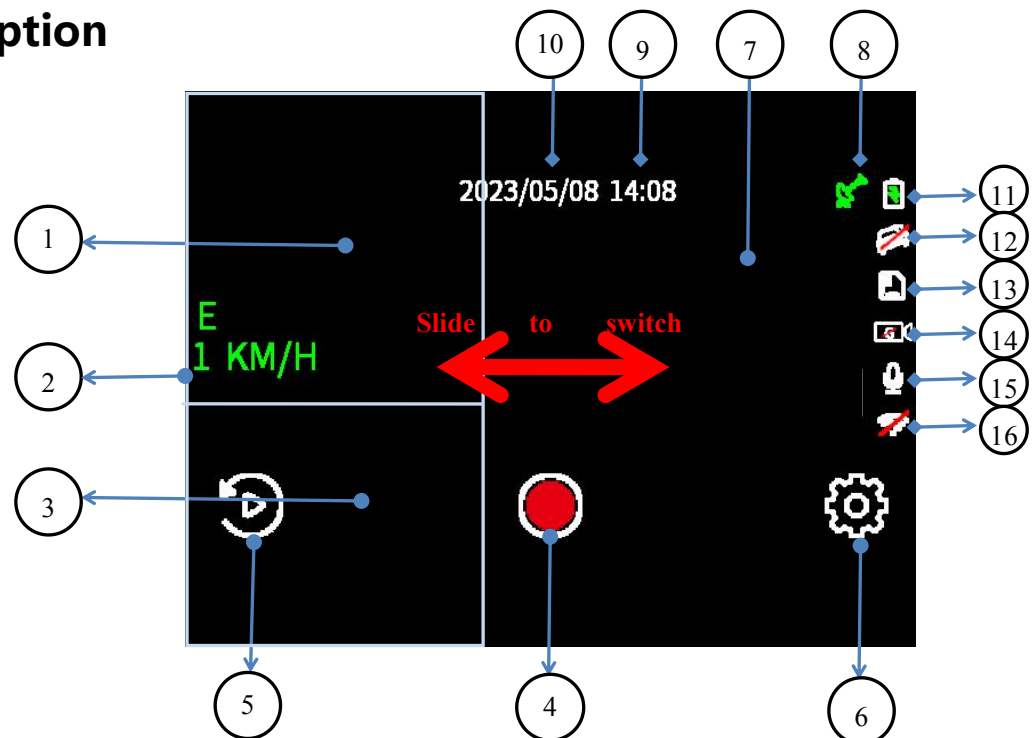

Note: Distribute and hide the car charger extension cable and rear camera (optional) extension cable along the car trim panel as shown in the pictures above.

Recorder function description

Touch function description

1. Recorder interface



1	In car window, double-click to switch to full screen or back	9	Time display, please set the time for first use
2	GPS speed direction display icon (requires GPS module)	10	Date display, please set the date for first use
3	Rear recording window, double-click to switch to full screen or back(3 Channels recording Optional)	11	Power icon ,  Power connected
4	Recording pause/recording, click to pause or record the video	12	Parking monitoring icon ,  Parking monitoring turned off
5	Playback, click to enter the video playback page, and play the video	13	Memory card insertion icon ,  Memory card normal
6	Settings, click to enter the menu settings, select photography, playback, and settings	14	Collision icon ,  Collision closure
7	Front window,swipe to switch display window.	15	Recording sound icon ,  Recording sound enabled
8	GPS icon, green indicates successful positioning	16	WIFI icon ,  WIFI turned off. opened in the settings

2.Main interface

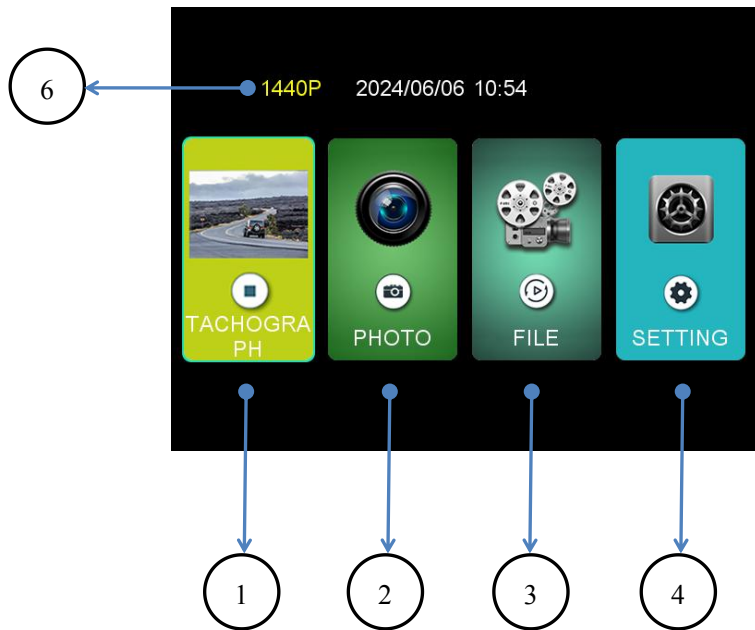

3.Photography interface

Click on the photo button to take a photo

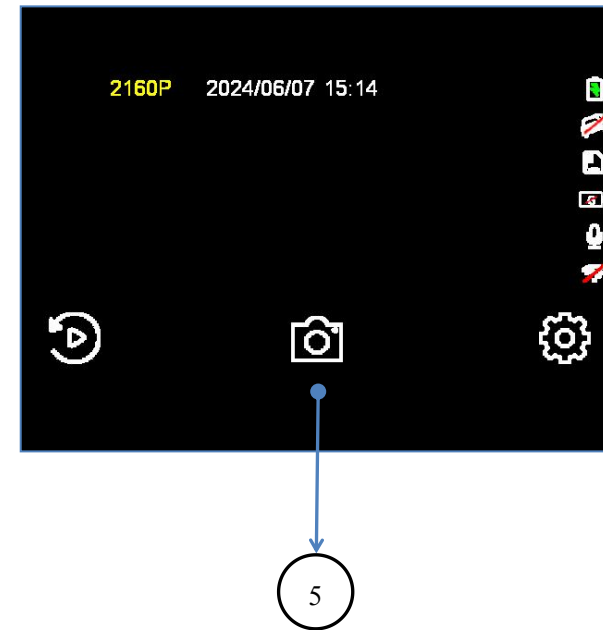

1	Driving recorder, click to enter the recorder interface	4	Settings, click to enter the menu settings interface
2	photo, click to enter the photo taking interface	5	photo button, click to take a photo
3	Video playback, click to enter the video playback interface	6	Resolution, the current recording resolution is 1440P

4.Playback interface

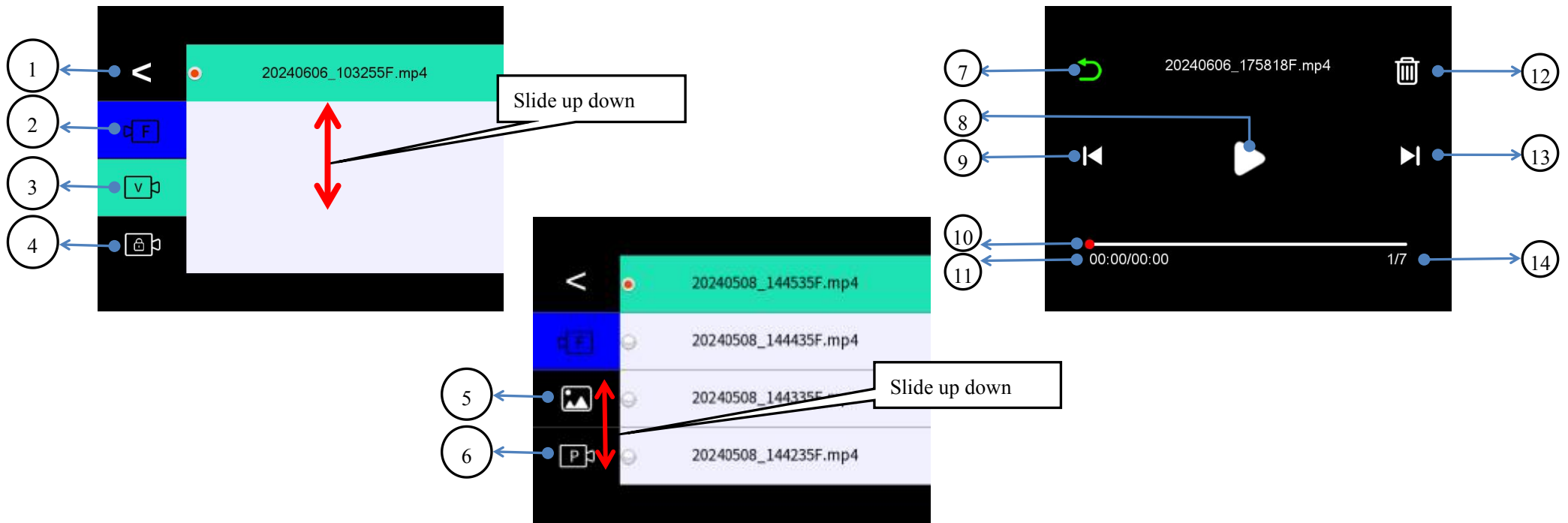

1	Return button, click to return to the recorder interface	8	Play/pause button, click to play/pause the current video
2	Front F/Incar M/Rear R; Video switch button, click to switch video file	9	Flip up button, click to switch to the previous video
3	Video, click on the right to display the video file	10	Video playback progress bar, displaying the current video playback progress
4	Lock video, click on the right to display the lock video file	11	Video duration, the total duration of the current video playback
5	Photo, click on the right to display the photo image	12	Delete key, click to delete the current video
6	Parking monitoring video, click on the right to display the parking monitoring video file	13	Scroll down key, click to switch to the next video
7	Return key, click to return to the higher-level menu	14	Number of videos, display 1/XXX of the number of videos on the card

5. System Set

5.1 Device mode

This machine can choose between **3 Channels recording modes** (front+incar+rear recording) and **2 Channels recording modes** (front+incar); There is a difference in recording resolution between the two display modes , As shown in the following figure :

Touch and click on options to operate settings

3 Channels recording modes

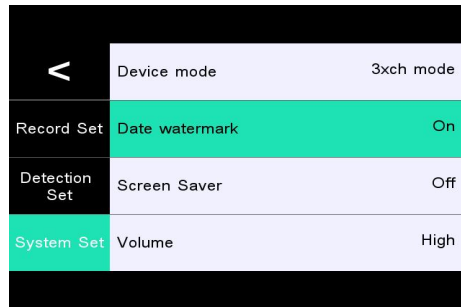

3 Channels recording Switch Options

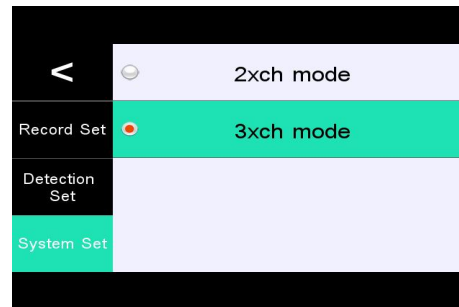

3 Channels recording resolution ratio

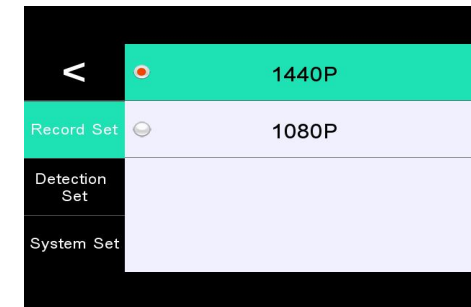

2 Channels recording modes

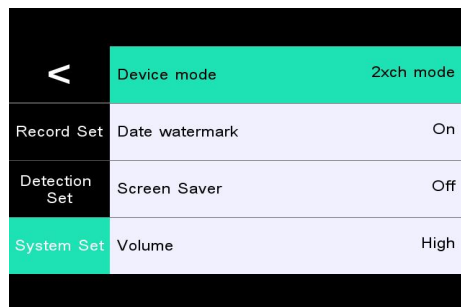

2 Channels recording Switch Options

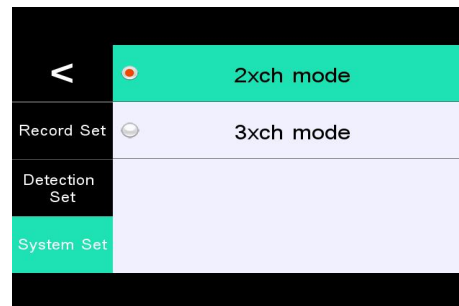

2 Channels recording resolution ratio

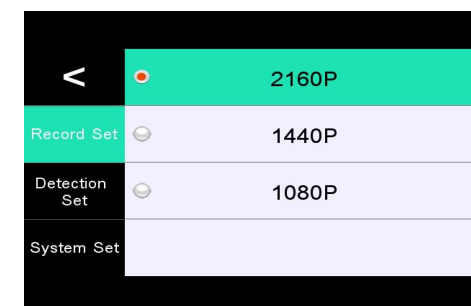

Note: The resolution option is for setting the parameters of the **front camera**, 1080P is standard in incar camera and rear camera, and rear camera is optional; If post recording is not required, it is recommended to set it to two recording mode to obtain a 4K video experience. The default three recording mode at the factory will format the TF card content when switching modes. Please pay attention to backup to avoid loss.

6. WiFi Set

6.1 WiFi switch, set WIFI On or Off. Default Off. (Not using WIFI)

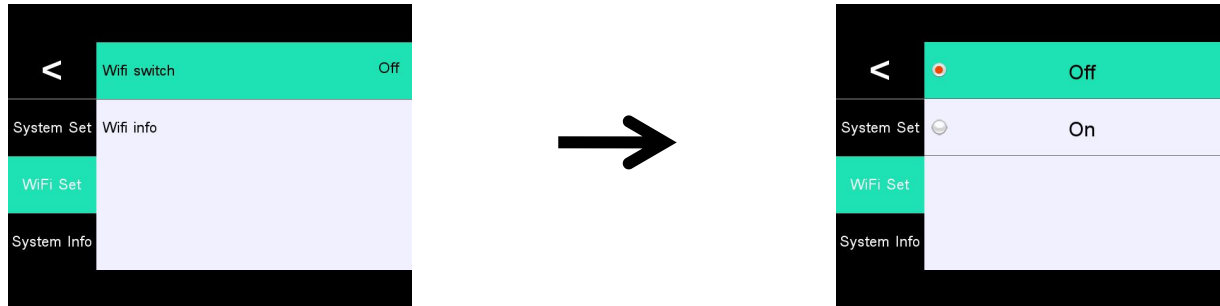

6.2 WIFI info, can view WIFI name, password information, and download mobile apps. (For detailed operations, please refer to the WIFI function description)

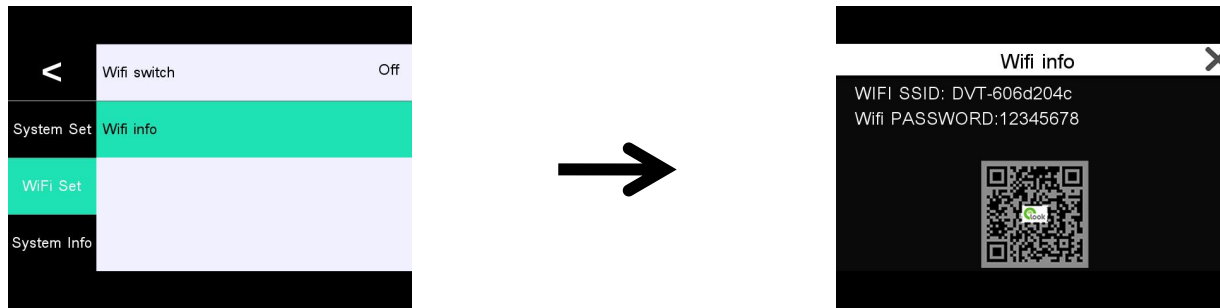

7. GPS Set

7.1 GPS switch, which sets the GPS to be enabled or disabled, with the default setting being enabled.

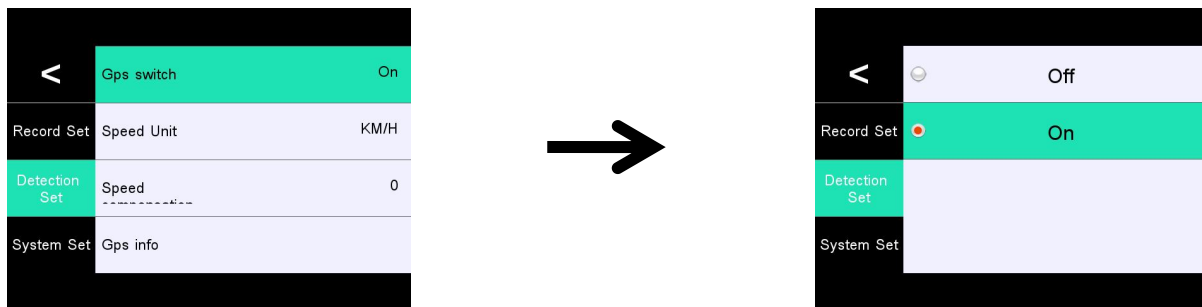

7.2 GPS Information: Check the GPS signal strength. For normal use, the GPS signal value should be greater than 40db, with a minimum of 4 satellites. If the signal strength is insufficient, change the installation location of the GPS module until the signal value meets the required level.

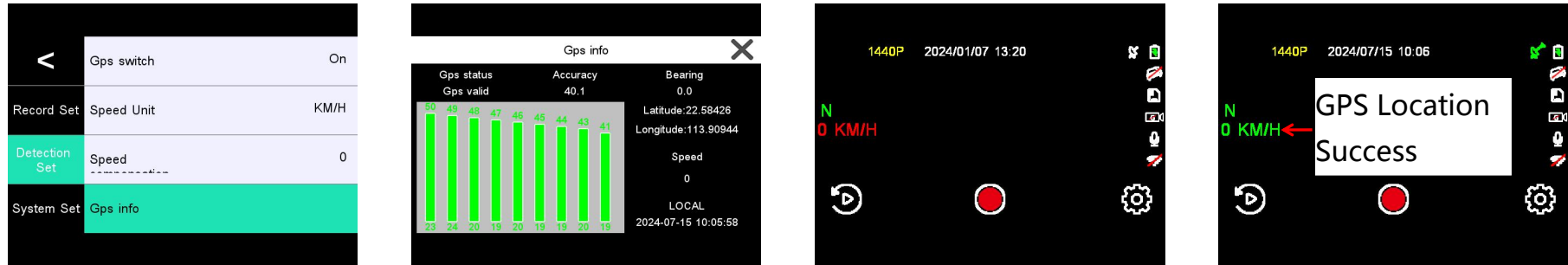

8.Voice Control(Optional) : This device supports English voice control. Voice commands can be used to operate the dashcam, but only pre-set commands are supported. The available commands include:Voice command list\Open screen\Close screen\Lock the video\Take picture\Show front camera\Show inside camera\Show rear camera\Show all camera\Open audio\Close audio.

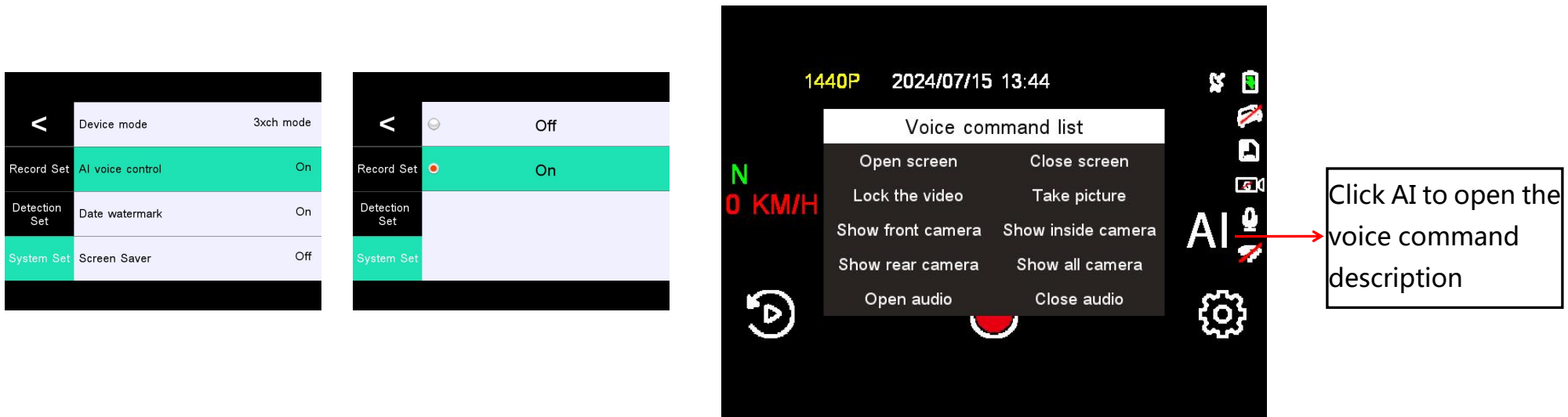

9. Time Zone Settings

The settings that influence the displayed time & date will be applied upon receiving a GPS connection.

Some examples of GMT time off sets are:

- GMT-7: Los Angeles
- GMT+10: Sydney
- GMT-4: New York

Please make sure to adjust time zone setting during standard vs.

Daylight savings time. If you are unsure of your GMT off set please look up your city on

<http://www.greenwichmeantime.com/time-zone/usa/>

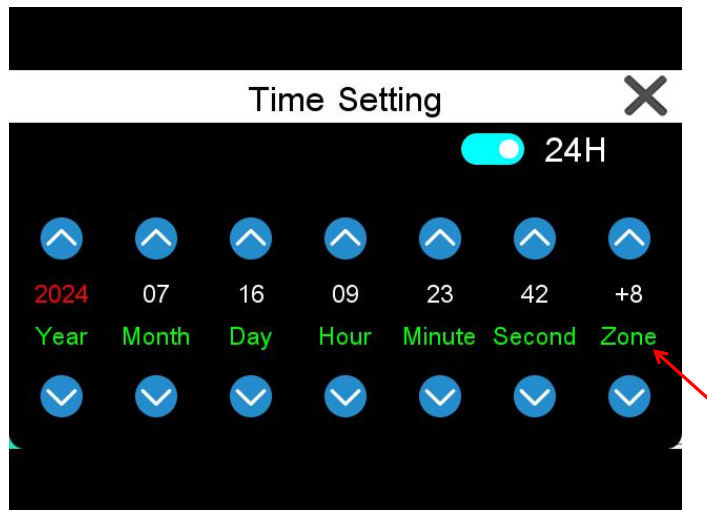

USA Time Zones	When Daylight Savi-ngs Ends Nov-March	When Daylight Savi-ngs Begins March-Nov
Hawaii	GMT (-10:00)	
Alaska	GMT (-9:00)	GMT (-8:00)
Pacific Time Zone	GMT (-8:00)	GMT (-7:00)
Mountain Time Zone	GMT (-7:00)	GMT (-6:00)
Central Time Zone	GMT (-6:00)	GMT (-5:00)
Eastern Time Zone	GMT (-5:00)	GMT (-4:00)

UK Time Zones	British Summer Time	British Winter Time
	GMT/UTC +1	GMT/UTC ±0

10. Playing Video Files Using Your Computer

1. Remove the micro SD card from the dash cam.
2. Insert the card into the micro SD card reader and connect it to a computer.
3. Run the hitlitlev1.0 download program to download the GPS track player. It will automatically download after running. Once completed, follow the prompts to automatically install, and click "Allow" for all permission requests.
4. Install the OMBAR GPS player on your computer.(Note: Please close or ignore the prompt of the anti-virus software, we confirm that it will not bring any security impact to your computer.)
5. You can click the "Open Files" button to browse and select the Movie or EMR folder of the micro SD card on the GPS player. It will show all files in the normal or event or parking folder. Or you can also drag the video files directly to the launcher screen.
6. There are two ways to play video.

A, Click File-Open icon to choose the folder which you want to play,click to start play.
(Note that you can ONLY select one folder to play and see no video files)

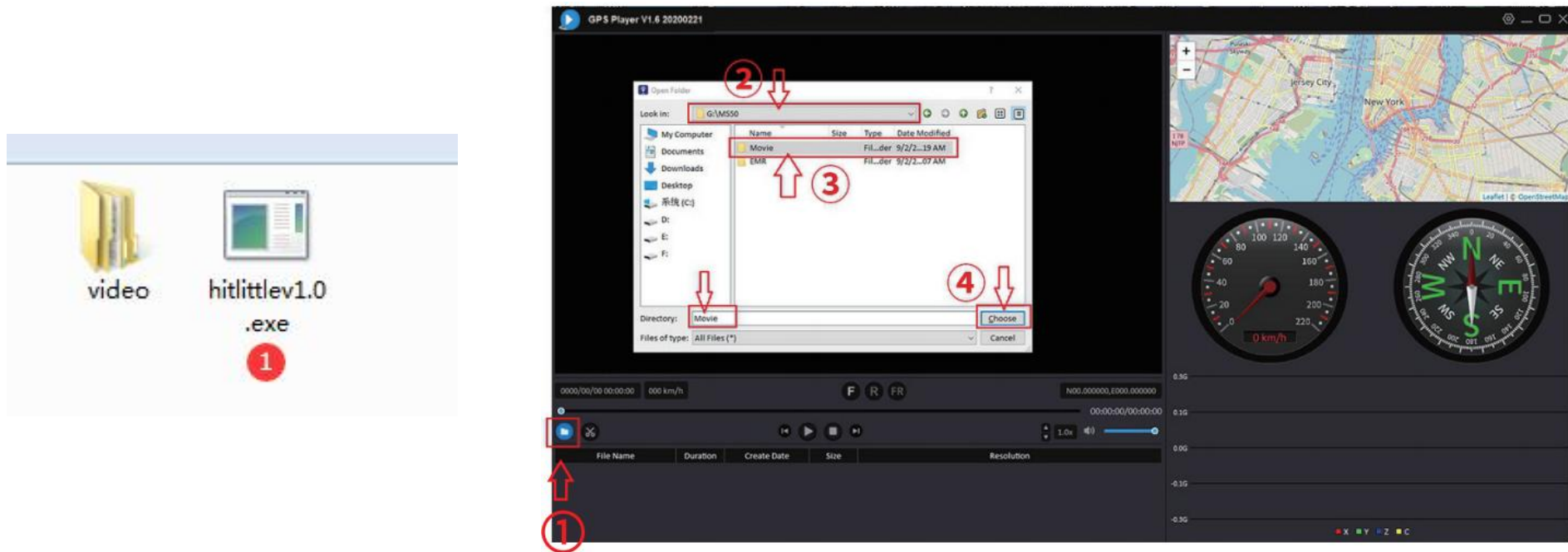

B, Select from "My Computer" and find the memory card disk, choose the video file you want to play, you can drag and drop the file directly to the player. You can get the GPS information on the player.

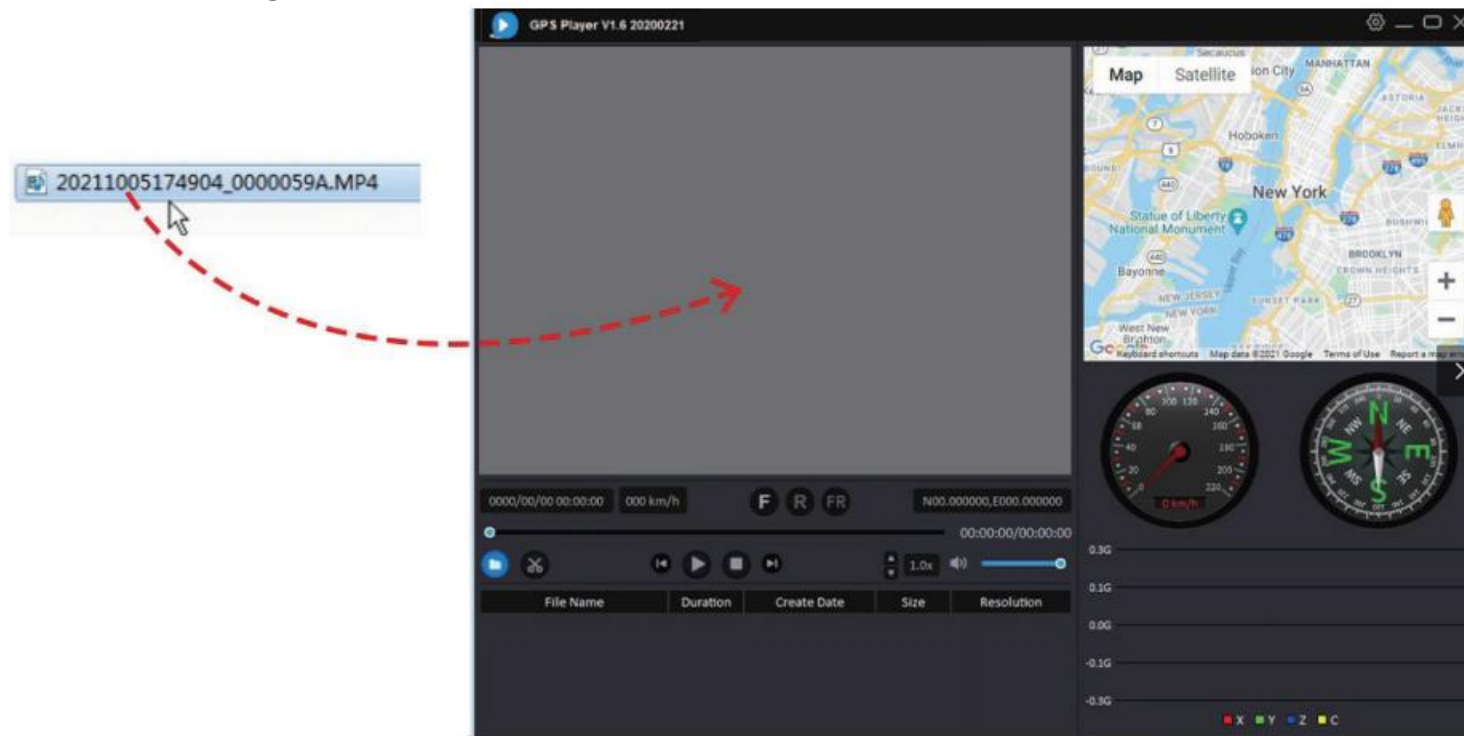

Folder name: front, this is the directory for front-facing video recordings. The video filenames follow the pattern XXXXXXXX_XXXXXXF, where F indicates a front-facing video.

Folder name: incar, this is the directory for in-car video recordings. The video filenames follow the pattern XXXXXXXX_XXXXXXM, where M (though it might be a mistake here, as typically it wouldn't stand for "front" but could be a placeholder for "in-car" or something similar; for the sake of this translation, I'll keep it as M) indicates an in-car video.

Folder name: rear, this is the directory for rear-facing video recordings (optional). The video filenames follow the pattern XXXXXXXX_XXXXXXR, where R indicates a rear-facing video.

WIFI connection

1. Long press the M key to turn on/off WIFI with just one click; Enter the menu - click on "WIFI switch" to turn on/off WIFI
2. Open the WIFI information, scan the QR code, and check the WiFi name: DVT-XXX WiFi password: 12345678
3. Download APP

There are two ways to download APP :

一、 Search for the APP in the App store to download :

For ios system, you can enter the App store and search for "ELookPro" to download

二、 Scan the QR code ios and android system, both can download "ELookPro" by scanning the QR code APP, the steps are as follows:

- (1) Open WeChat or others with a "scan" function
- (2) Select the corresponding system of the mobile phone, click to download



Capable software, scan the "ELookPro" QR code

3. APP connection method

Open the app

click to connect camera

click to Set The WI-FI

connect WIFI

recording interface

5:00 Device



Connect camera



5:00

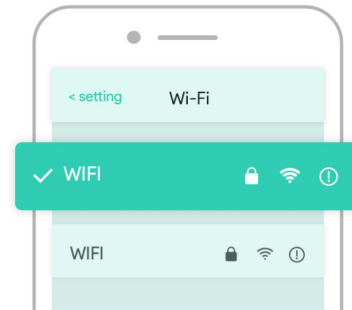

Default Password:12345678

Set The Wi-Fi

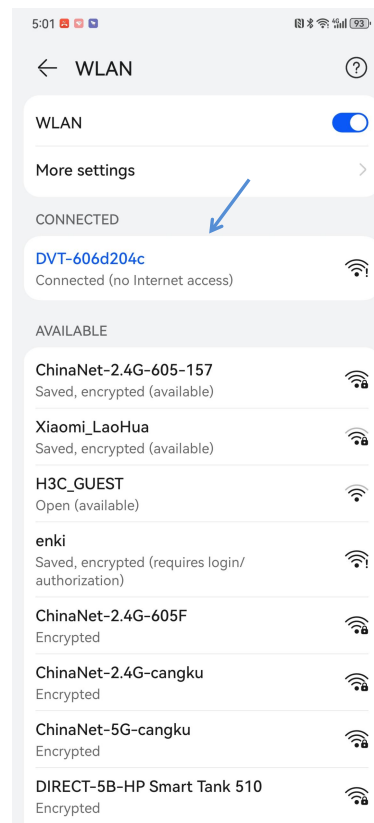

4:58

Switch front/incar/rear

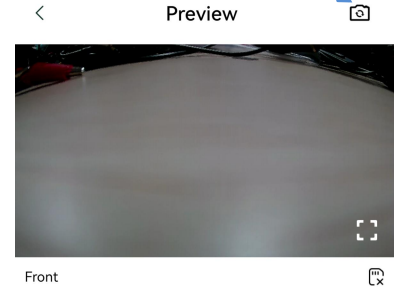

Click to pause recording

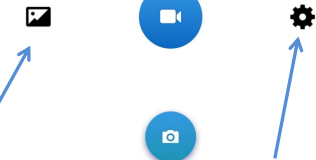

Click to view video

Click to enter settings

Manual one-touch file lock function

Touch click the "Lock icon" button in the video mode, you can lock the current recording file with one key, the locked file will not be overwritten by the loop, and the locked file cannot be deleted (only when doing file deletion operation on the car recorder, if you choose to format the card, then all files in the card including the locked file will be deleted).

Automatic document lock function

This machine has a built-in three-axis gravity-sensing chip, the vehicle in the process of driving a traffic accident, the vehicle was hit when the machine can automatically lock the current video protection, for the accident investigation and evidence to provide strong evidence!

Warm tips : Video locking time is based on the length of the video set in the recorder settings menu

The video locking time is based on the recording length set in the recorder setting menu, the loop recording menu has "1/3/5" three gears, If you set the recording time to 1 minute, the video locking time is 1 minute!

AVin input function

The camera supports AVin video input, when used with the rear pull lens, the camera supports picture-in-picture display, automatically switch to the rear pull lens image when reversing and automatic full-screen display.

Warm tips : Pull back the reversing trigger wire of the lens, the red wire is connected to the positive pole of the reversing light, the voltage is less than 12V.

Parking monitoring function

This machine has a parking monitoring function. After the parking monitoring function is turned on, when your car is "struck", the recorder will automatically turn on and record, record the image at the time of the incident, and escort your car.

One key WIFI function

In standby mode and recording mode, long press the M key to turn on/off WIFI.

Special features:

1. Rear view

First, the car charger must be connected to the recorder, and the red wire on the rear camera must be connected to the positive electrode of the reversing light. After the car is started, the device will automatically start the video recording state, and if there is reversing in any state, the reversing image will be displayed. The machine will automatically return to the video mode after the reversing is visible. (**This function is not available for special models with reverse control line as negative**)

2.RESET reset

If the machine is abnormal or crashes during use, you can press the RESET button through a small needle through the small hole of the shell to reset the machine.

Product specification sheet:

product name	Logger
Features	HD camera
Front resolution	2160P (2 Channels recording) 1440P (3 Channels recording)
Incar resolution	1080P
Take pictures	stand by
screen size	3 inches
Lens	A+ level high-resolution wide-angle lens
Language	English\Chinese\French\German\Italian\S panish\Japanese-Russian\Vietnamese\Kor ean\Arabic\Portugal
Video file format	MP4
Photo file format	JPG
GPS	stand by(Optional)
Color effect	standard
Uninterrupted loop recording	Seamless loop recording, no seconds lost
On-board switch machine	Support car ignition to turn on, turn off the car
Post-recording	HD post-recording

Year month day hour minute	stand by
Lens aperture	F2.0
Night vision function	stand by
Rear resolution	1080P
Incar camera	Infrared HD camera
storage card	C10/U3TF card(Supports up to512GB)
Reverse image	stand by
microphone	stand by
Built-in audio	stand by
Time-lapse video	stand by
Current frequency	50HZ/60HZ
USB function	stand by
power supply	5V
battery	Built-in battery
Parking monitoring	stand by

Troubleshooting

Under normal operating conditions, if the product has abnormal problems, please refer to the following methods to solve.

Can not boot:

Check whether the wiring is installed correctly; or take out the memory card and restart the machine.

Automatically stop recording during recording, or do not cycle recording:

Due to the huge amount of high-definition video data, it is possible that the read and write speed of the memory card cannot keep up. Please use a high-speed TF card such as a C10 high-speed card.

The film is not clear:

Please check the lens for dirt and fingerprints. Please clean the surface of the lens before shooting to keep the lens clean and tidy.

Sometimes the effect of the film is good and bad:

The camera effect has a lot to do with the shooting light environment, such as backlight, forward light, and the intensity of the light will cause different video effects.

There are streaks in the image:

This is caused by setting the wrong "source frequency" under fluorescent lamps, and the domestic frequency is "50HZ".

CUSTOMER SERVICE :

Defective or damaged item?

Inaccurate description?

Missing parts or accessories?

Performance or quality not adequate?

Wrong item was sent?



service@juscar.com

Response in just 24 hours

**Contact us before returning the item.
We will help you resolve any issue asap.**

Disclaimer

The recorder is an instrument for recording related information such as images and sounds during the driving of the vehicle. Accidents, etc. are only used as an auxiliary reference to avoid user misunderstanding:

Special note: The machine must be in the recording working state before it can record files.

However, the image will be damaged or lost in the following situations:

1. During recording, pulling out the TF card will cause the last recording file to be damaged or lost.
2. Illegal power failure during recording will cause the last image to be damaged or lost.
3. The video film is damaged or lost due to the destructive collision of the machine during the video recording.
4. Excessive collision during the recording process causes the memory card to become loose at the time, which will damage the files at the time or cause the files to be lost.

The audio and video recorded by the driving recorder are for reference only, and our company shall not be jointly and severally liable for any loss caused by bad files or data loss caused by abnormal conditions of the machine.

Hereby declare